

# <THESE INSTRUCTIONS MUST BE GIVEN TO THE END USER>



**B&W Trailer Hitches**  
 1216 Hawaii Rd / PO Box 186  
 Humboldt, KS 66748  
 P:800.248.6564  
 F:620.869.9031

Call or Email us for  
 Installation Support  
 hitches@turnoverball.com  
 bwtrailerhitches.com

## Custom 5th Wheel Hitch Mounting Rail Installation Instructions

# MODEL 2605

See Limited Lifetime Warranty at  
[bwtrailerhitches.com/warranty](http://bwtrailerhitches.com/warranty)

2013 RAM 2500 Trucks  
 2013-2022 RAM 3500 Trucks

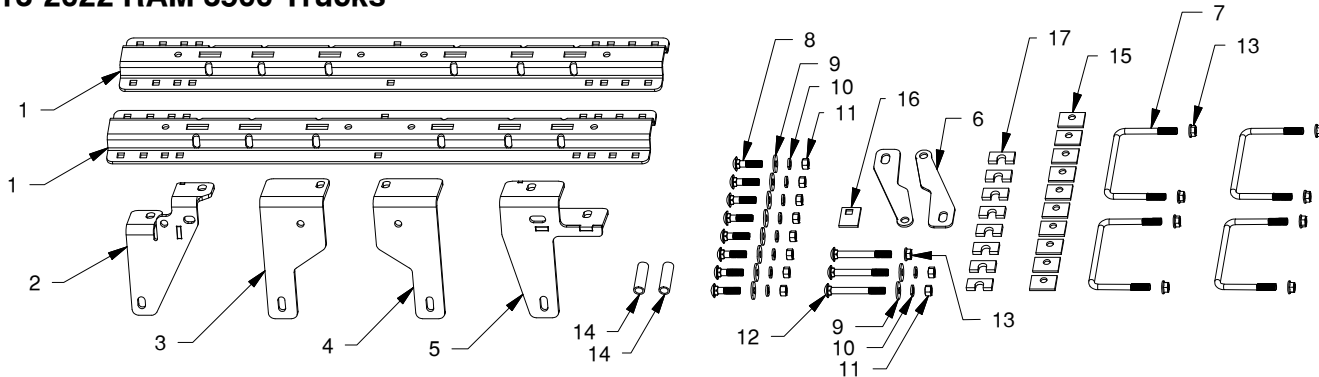

Patriot Rail Box (RVR3210)		
ITEM	DESCRIPTION	QTY
1	Mounting Rail	2

Bracket Set Box (RVR2605)		
ITEM	DESCRIPTION	QTY
2	Driver Side Rear Bracket	1
3	Passenger Side Front Bracket	1
4	Driver Side Front Bracket	1
5	Passenger Side Rear Bracket	1
6	Stiffening Plate	2
7	1/2" X 6 3/4" X 4 1/2" U-Bolt	4

Bracket Set Bolt Bag #1		
ITEM	DESCRIPTION	QTY
8	1/2" X 2" Carriage Bolt	8
9	1/2" Flat Washer	10
10	1/2" Split Lockwasher	10
11	1/2" Finish Nut	10
12	1/2" X 4 1/2" Carriage Bolt	3
13	1/2" Flange Nut	9
14	Tube Spacer	2

Bracket Set Bolt Bag #2		
ITEM	DESCRIPTION	QTY
15	Offset Rectangle Washer	10
16	Square Washer	1
17	5/16" U-Shaped Spacer	8

## **⚠ WARNING** Failure to comply with the safety information in these instructions could result in serious injury or death.

- ⚠** Read all installation and operating instructions along with all labels before using this product.
- ⚠** Adding components to the chassis of any vehicle can be hazardous. There is potential for damage to vehicle, injury from tool usage and many other hazards. This installation must be completed by someone who is aware of the hazards involved. This person must be knowledgeable of proper safety procedures for a vehicle installation of this nature, and for usage of the equipment required to perform the installation.
- ⚠** Without proper knowledge, towing can be a dangerous activity. Understand all the risks involved with towing before proceeding. For information on towing safety, see **"The Trailer Handbook: A guide to Understanding Trailer and Towing Safety"** from the *National Association of Trailer Manufacturers*, [www.NATM.com](http://www.NATM.com) and your trailer manufacturer's owner's manual.
- ⚠** Do not exceed tow or tongue rating of coupler, tow or tongue rating of hitch, or tow or weight ratings of truck or trailer. See vehicle and trailer manufacturer information for ratings. Exceeding these ratings may cause damage to towing components or loss of attachment between the trailer and truck.
- ⚠** Additional caution must be used when towing a wedge car trailer. Towing stability greatly depends on keeping the center of gravity as low as possible. Load heavy cars over the axles. Never tow with a single car on the front of the trailer. When towing a wedge car trailer, never exceed speeds that are reasonable for the roadway conditions (e.g. turns, going around a curve, etc.). Failure to account for proper trailer center of gravity and speeds that are reasonable for the roadway conditions may cause damage to the truck, trailer, towing components, and loss of attachment between the truck and trailer.
- ⚠** Do not modify this product in any manner. Doing so could alter its integrity and lead to a loss of attachment between the trailer and the tow vehicle.
- ⚠** A visual inspection of the hitch should be performed before each time you tow. Regularly check that all pinned connections are secure, and that all bolted connections are at the correct torque specification. Check for cracks or damage to the hitch. Do not tow with the hitch if cracks or damage outside of normal wear is found. Towing with a hitch that has cracks or damage could result in damage to the tow vehicle, trailer, towing components and loss of attachment between the tow vehicle and trailer.

# PREPARING TO INSTALL

**NOTICE:** It may be necessary to remove the spare tire and/or heat shield before installation.

**NOTICE:** If truck is equipped with a removable bed liner or mat, it should be removed or it must be cut to allow the mounting rails to connect directly with the bed. It is acceptable to install the mounting rails over a spray in bed liner.

**NOTE:** Remove all parts from the packaging and familiarize yourself with all the parts and tools required. Use the parts list on the front page to verify that all parts and hardware are present.

**⚠ WARNING:** Do not install frame brackets or U-bolts over wiring or brake lines. Always place the hitch components directly against the frame of the truck. Failure to move such components can lead to property damage or serious injury.

Installation of the mounting rails requires several common tools and a few specialized tools. Below is a listing of equipment used during a typical installation.

- Impact wrench or ratchet with a 3/4" socket
- 3/4" box end wrench
- A drill and 1/8", 9/16" and 7/8" Drill bits
- Patriot 5th wheel or Slider Base
- Hammer
- Flashlight
- Tape Measure
- Eye Protection
- Ear Protection
- Torque Wrench
- Center Punch Tool

## DRILL REAR MOUNTING HOLES

- 1. Layout the rear mounting rail.** Place a mounting rail onto the bed of the truck. Hook a tape measure over the rear edge of the bed (not on any part of the tailgate), measure the location for the mounting rail as shown in Figure A1. Next, center the mounting rail in the bed by measuring the distance on either side from the edge of the rail to the sides of the bed. The rail will be centered when both measurements on either side of the rail are the same.

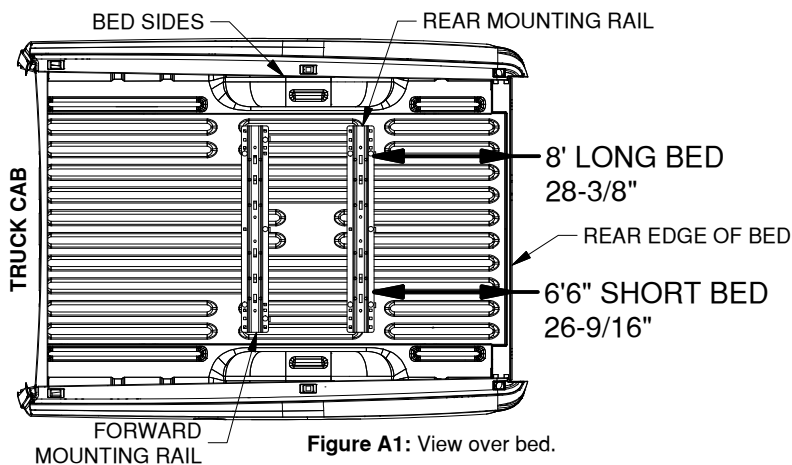
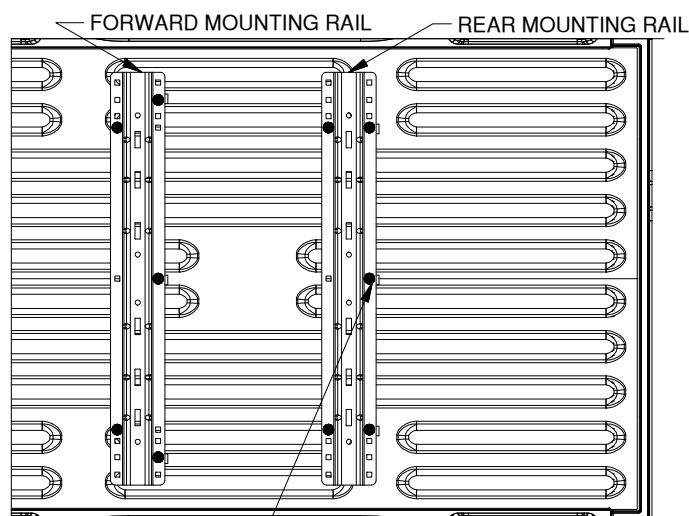

Figure A1: View over bed.

**IMPORTANT:** The mounting rail is designed to install only at the described location. Failure to place the mounting rail precisely may result in added difficulty during installation and/or property damage.

- 2. Mark hole locations.** While carefully ensuring the mounting rail does not move, use a center punch tool to mark the 5 drill locations on the rear rail. See Figure A2 for hole marking locations for this installation (forward rails will install on a later step). Once all 5 rear rail locations are clearly marked, move the bed rail out of the way and drill each location with an 1/8" drill.

**NOTE:** The two forward drill locations on the rear rail are directly above a bed cross member. The drill must pass through both the bed and the cross member and should be as straight as possible when drilled.



DRILL LOCATIONS HIGHLIGHTED BY BLACK DOTS Figure A2: Detail view over bed, showing drill locations for the forward and rear bed rails.

- ⚠ WARNING:** The fuel tank of the truck may be directly below the area of the bed which needs to be drilled. Always carefully examine the area under the truck where drilling will occur before drilling. Make certain that the tank, or other equipment, is not damaged during drilling. Damage to the tank may result in property damage, serious injury or death.

- 3. Check hole locations.** Locate the driver side frame bracket, stiffening plate, a U-bolt, the square washer and a 1/2" x 4 1/2" carriage bolt. Position and hold the bracket and stiffening plate flat against the inside of the frame where it will be installed, see Figure A3. Pass the carriage bolt and U-bolt from the outside of the frame through the corresponding holes in the top of the frame and through the bracket and stiffener plate, see Figures A4 and A5. Check that the 1/8" pilot holes are centered within the slots in the frame brackets. If the 1/8" drilled holes are not centered within the slots, re-drill the 1/8" holes until the brackets and the drilled holes are aligned. Repeat the process for the passenger side using the passenger side rear bracket and a U-bolt, see Figures A6 and A7. continued on next page...

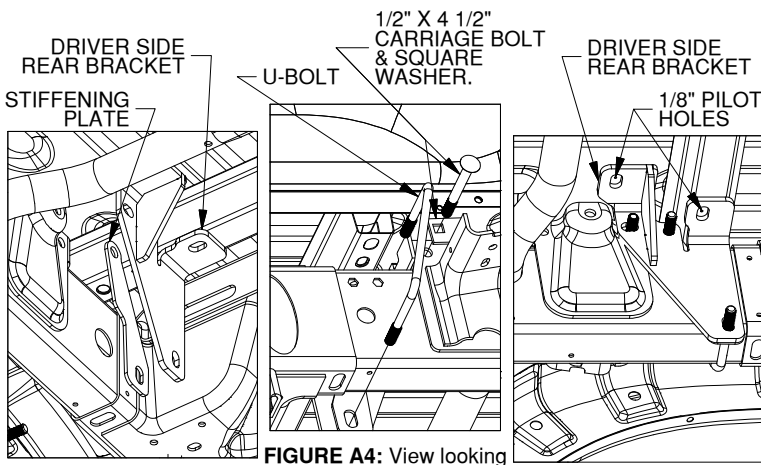

**FIGURE A3:** View looking up at the outside of driver side frame.

**FIGURE A4:** View looking up at the inside of driver side frame.

**FIGURE A5:** View looking up at the inside of driver side frame.

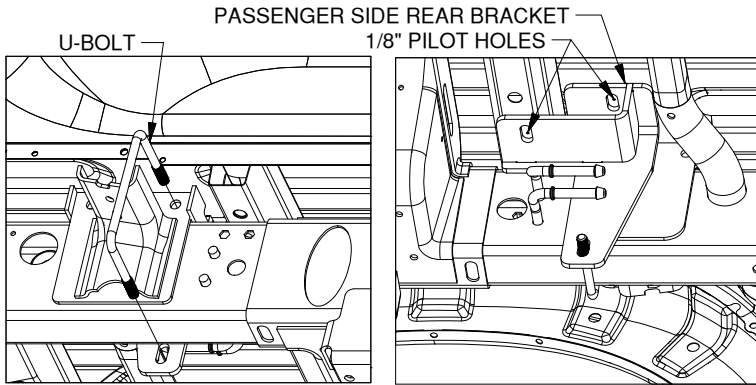

**FIGURE A6:** View looking up at the outside of passenger side frame.

**FIGURE A7:** View looking up at the inside of passenger side frame.

- 4. Enlarge the holes.** Using the 1/8" holes as pilots, drill out the 3 rear most drill locations with a 9/16" bit. Drill out the 2 forward drill locations with a 7/8" drill. The 7/8" holes should be in the bed only. Drill the holes in the bottom of the cross member under the 7/8" hole with a 9/16" bit.

## INSTALL REAR MOUNTING RAIL

**NOTICE:** Due to the corrugation of the truck bed, U-shaped spacers are provided to function as space fillers between the mounting rails and the kit attachment hardware. Always place a U-shaped spacer in the gap either above the bed (between the mounting rail and the bed) or below the bed (between the bed and the side mounting brackets). Failure to use U-shaped spacers will result in property damage when hardware is tightened.

- 1. Place the rear mounting rail.** Locate the two tube spacers, place a tube spacer into each of the 7/8" drilled holes. Re-position the rear mounting rail over the drilled 9/16" and 7/8" holes in the bed. Install two 1/2" X 4 1/2" carriage bolts into the two forward drilled positions (7/8" holes over the cross member) and install three 1/2" X 2" carriage bolts through the three rear drilled positions, as shown in Figure B1. Place a U-shaped washer between the bed and the mounting rail at the three rear drilled positions.

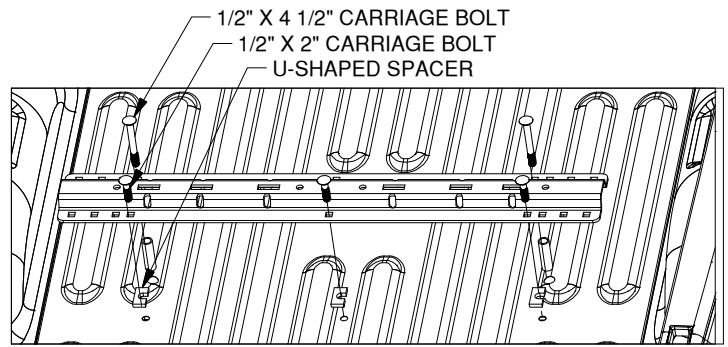

**Figure B1:** View looking into truck bed from rear of truck.

- 2. Install the rear frame brackets.** Fasten each U-bolt to the frame with two 1/2" flange nuts. Wiring may need to be pulled away from the frame to allow U-bolt to pass over the frame. Fasten the 1/2" X 4 1/2" carriage bolt on the driver side bracket with a 1/2" flange nut, see Figures B4 and B5. Install an offset rectangle washer, 1/2" flat washer, 1/2" lock washer and 1/2" nut on each of the carriage bolts passing down through the bed, as shown in Figure B6. Hand tighten each nut.

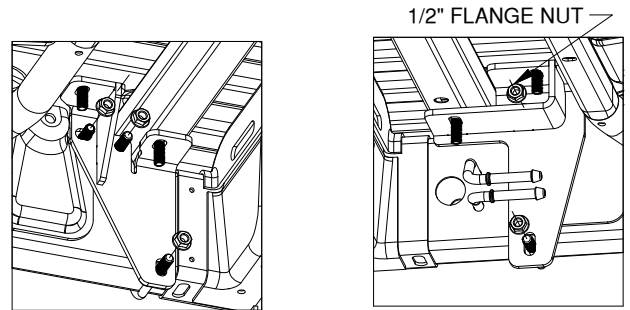

**FIGURE B4:** View looking up at the inside of driver side frame.

**FIGURE B5:** View looking up at the inside of passenger side frame.

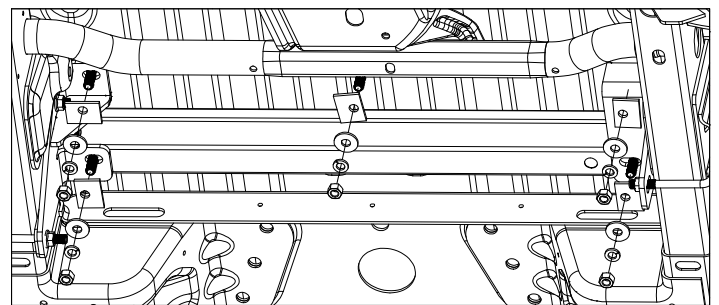

**FIGURE B6:** View looking up at the bottom of the truck bed.

## INSTALL FORWARD MOUNTING RAIL

- 1. Position the forward mounting rail.** For this step the base which will be used in the mounting rails is required. Place a mounting rail into the truck bed in front of the rear mounting rail. Place the base over the rail attachment points and carefully lower it until the pin tabs pass through the attachment points on the rear mounting rail. Attach the forward mounting rail to the forward mounting points on the base. The base should rest flat against the top of the rails, see Figure C1. With the base still attached ensure that the forward rail is centered in the truck bed.

continued on next page...

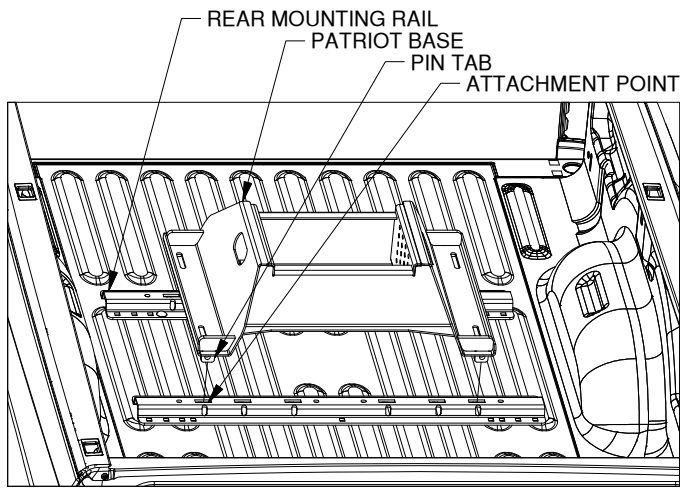

Figure C1: View into truck bed looking towards tailgate.

**IMPORTANT:** Before drilling forward mounting holes pull the RV base towards the rear of the truck and push the forward rail towards the cab of the truck to correctly space the mounting rails, see Figure C2.

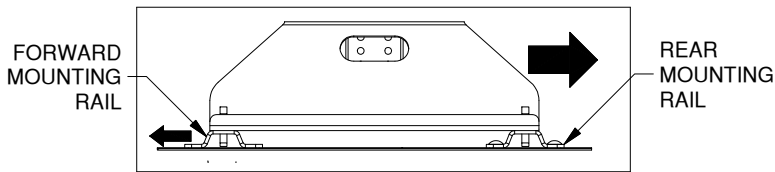

Figure C2: Side view of RV base and mounting rails.

2. **Drill forward mounting holes.** Using the same methods as used for the rear mounting rail, mark and drill the 1/8" holes for the forward mounting rail. Refer to "DRILL REAR MOUNTING HOLES" section, step 2, on a previous page. Notice that the hole locations are slightly different than the rear rail, see Figure A2 (on the second page).
3. **Enlarge the holes.** Remove the base and move the forward rail out of the way. Use the 1/8" holes as pilots, and drill out each hole with a 9/16" bit.
4. **The forward mounting rail.** Re-position the forward mounting rail over the drilled 9/16" holes in the bed. Install five 1/2" X 2" carriage bolts through the five drilled positions, as shown in Figure C3. Place a U-shaped spacer between the bed and the mounting rail at the five drilled positions.

THESE U-SHAPED SPACERS MAY NOT STRADDLE THE BOLT DUE TO BED CORRUGATION. PLACE UNDER RAIL NEAR BOLT.

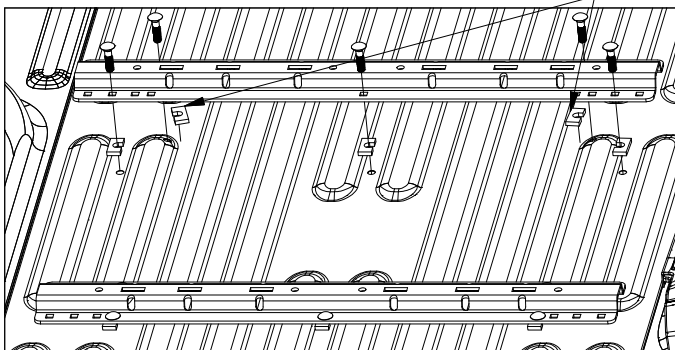

Figure C3: View looking into truck bed from rear of truck.

5. **Install front brackets.** Locate the driver side front bracket, a U-bolt, a stiffening plate, and two flange nuts. Move any wiring on the frame so it will not interfere with the bracket. Position the bracket behind the cross member under the installation location of the forward mounting rail. Maneuver the bracket so that the 1/2" carriage bolt passes through the slot at the top of the bracket as shown in Figure C4. While holding the bracket flat against the outside of the frame pass the U-bolt over the frame and through the bracket and stiffening plate. Secure with two 1/2" flange nuts, see Figure C5. Repeat for passenger side. The passenger side does not use a stiffening plate. Hand tighten each nut.

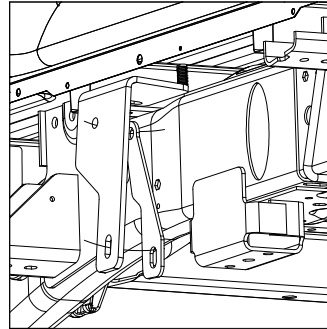

Figure C4: View looking at outside of driver side frame.

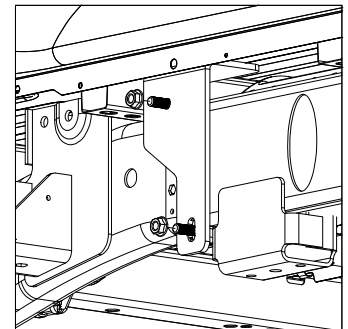

Figure C5: View looking at outside of driver side frame.

6. **Secure the forward mounting rail.** Under the bed install an offset square washer, 1/2" flat washers, 1/2" lock washer and 1/2" finish nut on each of the carriage bolts, see Figure C6. Hand tighten each nut.

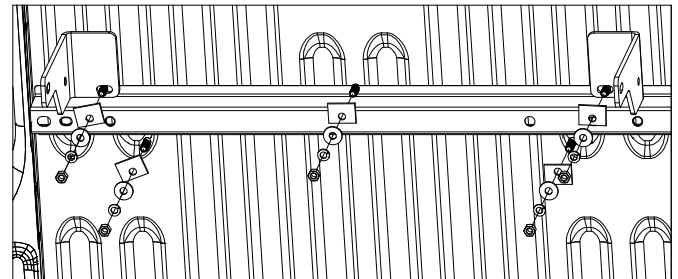

Figure C6: View under bed looking up. (Frame not shown)

7. **Tighten hardware.** Using a torque wrench, first torque all the 1/2" nuts in the mounting rails to 80 ft-lbs. Second, torque all 1/2" nuts in the frame brackets to 80 ft-lbs.
8. **Secure frame elements.** If any wiring was moved or detached during installation, check that it has been re-secured to the frame. Reinstall the heat shield and spare tire if necessary.